

---

# Table of Contents

<b>1 Safety Information</b> .....	- 1 -
<b>2 Product Overview</b> .....	- 2 -
2.1 Front panel features.....	- 2 -
2.2 Rear panel features .....	- 2 -
2.3 UPS with isolation transformer .....	- 3 -
<b>3 Installation</b> .....	- 4 -
3.1 Unpacking inspection.....	- 4 -
3.2 Installation information .....	- 4 -
3.3 Single system installation and output connection .....	- 5 -
3.4 Parallel system installation and output connection .....	- 8 -
3.5 External battery connection (long back up model) .....	- 11 -
3.6 Network functions .....	- 12 -
<b>4 Panel Function and Operation</b> .....	- 14 -
4.1 Keys function .....	- 14 -
4.2 LED Function .....	- 16 -
4.3 LCD display function.....	- 16 -
4.4 On/Off operation .....	- 17 -
4.5 Single UPS self-test/mute operation .....	- 18 -
4.6 Single UPS panel function setting.....	- 18 -
4.7 Parameters inquiring operation .....	- 22 -
<b>5 Operation Mode</b> .....	- 24 -
5.1 Bypass mode.....	- 24 -
5.2 Line mode .....	- 24 -
5.3 Battery mode .....	- 24 -
5.4 ECO mode .....	- 25 -
5.5 Fault mode.....	- 25 -
<b>6 Fault Messages and Alarm</b> .....	- 25 -
<b>7 Troubleshooting</b> .....	- 27 -
<b>Appendix 1: EMC Level</b> .....	- 29 -
<b>Appendix 2: Symbols</b> .....	- 29 -
<b>Appendix 3: Specifications</b> .....	- 30 -
<b>Appendix 4: Physical</b> .....	-31-

---

# 1 Safety Information

## 1.1 UPS safety information

- Read all safety information and operating instructions carefully before attempting to install, service or maintain the UPS. Save this manual properly for reuse.
- This UPS is intended for indoor use only.
- Do not operate this UPS in direct sunlight, in contact with fluids, or where there is excessive dust or humidity.
- Be sure the air vents on the UPS are not blocked. Allow adequate space against the wall for proper ventilation.
- Do not open the UPS case as you will, there is a high risk of electric shocks inside. All connection/wiring/servicing must be performed by a qualified electrician.
- Do not connect to the equipment like hair dryer or electric heater.
- Do not use liquid extinguisher if there is a fire, a dry powder extinguisher is recommended.

### **⚠ CAUTION**

UPS has high voltage inside. Do not repair it by yourself. If any questions, please contact local service center or dealer.

## 1.2 Battery safety information

- Environmental factors impact battery life. Elevated ambient temperatures, poor quality utility power, and frequent short duration discharges will shorten battery life. Replacing battery periodically can help to keep UPS in normal state and assure backup time required.
- Battery installing or replacing should be performed by a qualified electrician. If you want to replace the battery cable, please purchase it from our local service center or distributors to avoid fever and lighter which can cause fire by inadequate power capacity.
- Batteries may cause electric shocks and have a high short circuit current, follow below requirements before installing or replacing the batteries.
  - A. Remove wristwatches, rings, jewelry and other conductive materials.
  - B. Only use tools with insulated grips and handles
  - C. Wear insulated shoes and gloves
  - D. Do not put the metal tools or parts on the batteries
  - E. Before disconnecting the terminals from the batteries, cut off all the loads to the batteries first.

- Do not dispose of the batteries with fire. The batteries may explode.
- Do not open or mutilate batteries. Released electrolyte inside is harmful to the skin and eyes, and maybe toxic.
- Do not connect the positive pole and negative pole directly, otherwise it cause electric shocks or will be on fire.
- The battery circuit is not isolated from the input voltage, high voltage may occur between the battery terminals and ground, check if there is no voltage there before touching.

## 2 Product Overview

### 2.1 Front panel features



### 2.2 Rear panel features

Standard model / Long backup model (output voltage is 208V/220V/230V/240V)

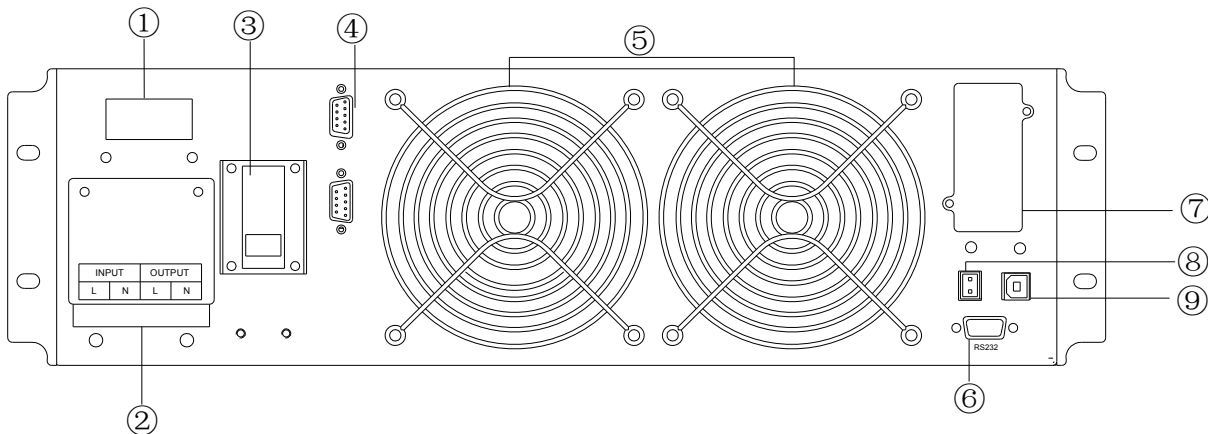

- ① Battery slot
- ② Terminal block
- ③ Overcurrent protector
- ④ Parallel Port
- ⑤ Fan
- ⑥ RS232 port;
- ⑦ Intelligent slot
- ⑧ EPO (Emergency Power Off)
- ⑨ USB

## 2.3 UPS with isolation transformer

For 6-10K UPS, it may be configured with isolation transformer. There are more output volatages to choose, including output 110V type.

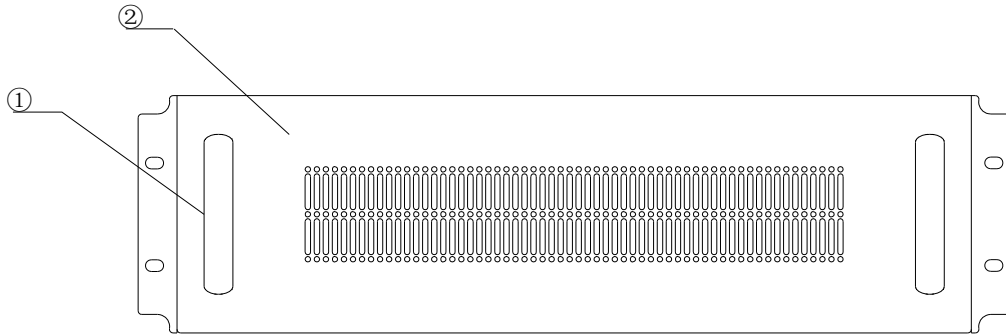

Front panel of UPS with isolation transformer

- ① Hanggrip      ② Front panel

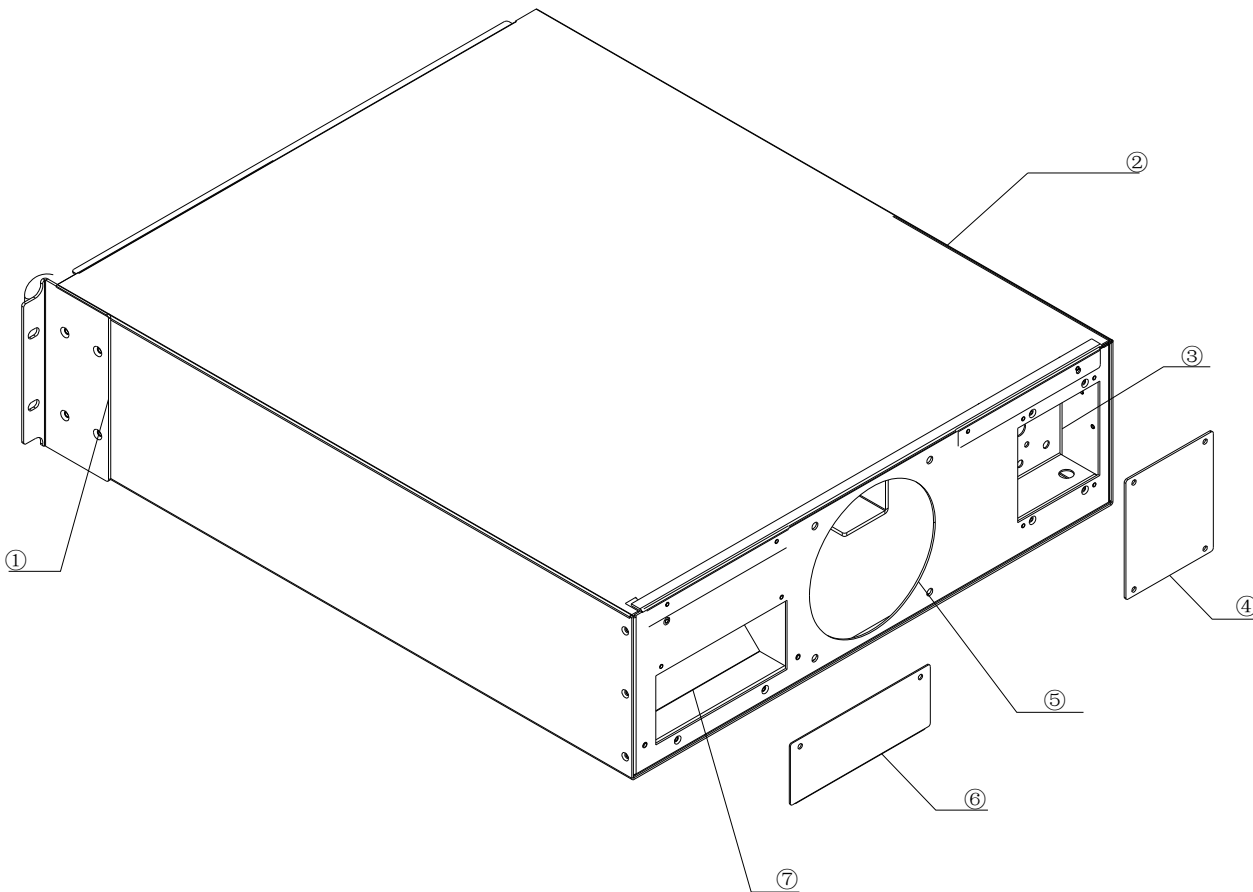

Rear/side panel of UPS with isolation transformer

- ① Mounting ear                      ② Case                      ③ Manual bypass switch room  
④ Manual bypass switch cover      ⑤ Fan                      ⑥ Input and output plate  
⑦ Input and output terminal

Note: The figure is for reference only. Due to the technology upgrading and development, the real unit might be different from the figure.

## 3 Installation

### 3.1 Unpacking inspection

- Open the UPS package and inspect the contents upon receipt. The accessories attached to the UPS contain a user manual, communication cable, support feet, CD-ROM. The long-back model also includes the cable for connection to battery bank.
- Check if the unit is damaged during transport. Do not power on and notify the carrier and dealer if find damaged or parts missing.
- Verify this unit is the model you want to buy. Check the model name showed both on the front panel and rear panel.

Model	Description	Model	Description
6KVARTS	6KVA RT Standard model	6KVARTH	6KVA RT Long backup model
10KVARTS	10KVA RT Standard model	10KVARTH	10KVA RT Long backup model

**Note:** Keep the packaging box and packaging materials for future transport use. The equipment is heavy. Always handle it with care.

### 3.2 Installation information

- The UPS installation environment must be in good ventilation, away from water, flammable gases and corrosive entities.
- Do not lie down the UPS against the wall so that front and side panel air intake hole, rear panel air outtake hole will be unobstructed.
- The ambient environment temperature around the UPS should be within 0 °C ~ 40 °C.
- If dismantling the machine at low temperatures, there may be condensation droplets, users can not install or operate it before UPS completely got dry both inside and outside, otherwise there will be danger of electric shocks.
- Place the UPS near the mains socket so that can cut off AC mains without any delay at any emergent case.
- Make sure the load connect to the UPS is off when users connect the load to UPS, and then turn on the load one by one later.
- Please connect the UPS with the socket which is over-current protected. Do not connect the UPS with the socket which rated current is less than the Maximum input current of the UPS.
- All the power socket should be configured with earthing device for safety.
- UPS could be electrified or powered no matter the input power cable is tied or not, even when the UPS is off. The only way to cut off the output is switching off the UPS and disconnecting the mains power supply.
- For all standard type UPS, it is advised to charge the battery over 8 hours before used. Once the AC mains power energizes the UPS, it will automatically charge the battery. Without prior charging, UPS output remains as usual but with shorter back-up time than normal.
- When connected to motor, display equipment, laser printer etc, UPS power selection should be based on the startup power of the load which is usually twice as rated power.
- When wiring, please ensure input cables and output cables are connected firmly.
- If install a leakage current protective switch, please install it on output cable.

●For 6-10K Series UPS, before installing, prepare wires for terminal block of the UPS based on the following table.

Model	Wiring specification (AWG)				
	Input	Output	Battery	Non-isolated Neutral	Ground
6KVA S	6mm <sup>2</sup>	6mm <sup>2</sup>	6mm <sup>2</sup>	6mm <sup>2</sup>	6mm <sup>2</sup>
6KVA H	6mm <sup>2</sup>	6mm <sup>2</sup>	6mm <sup>2</sup>	6mm <sup>2</sup>	6mm <sup>2</sup>
10KVA S	10mm <sup>2</sup>	10mm <sup>2</sup>	10mm <sup>2</sup>	10mm <sup>2</sup>	10mm <sup>2</sup>
10KVA H	10mm <sup>2</sup>	10mm <sup>2</sup>	10mm <sup>2</sup>	10mm <sup>2</sup>	10mm <sup>2</sup>

### 3.3 Single system installation and output connection

#### 3.3.1 Tower installation

The UPS system is packaged with feet and extensions, those can be used to install tower UPS model.

- ① Take out two groups of feet and extensions from package, assemble by embedding them with each other as shown in step1, Place the two support feet in parallel on horizontal surface, and then put the machine into two support feet carefully as shown in step2 and step3. Make sure the mains power is off when you move it.

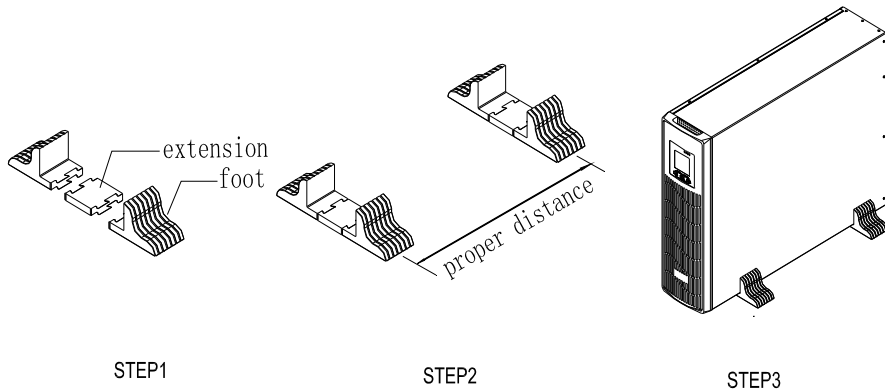

- ② The battery pack and the UPS unit can be put together, install as the following steps, please do not install the UPS upside down.

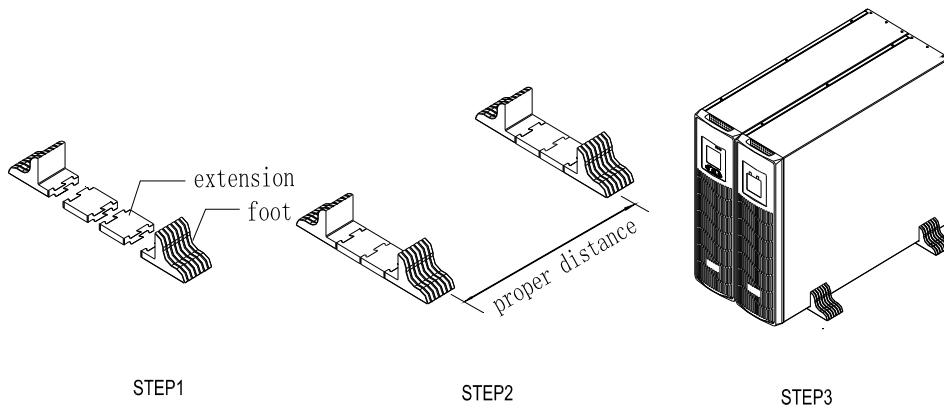

- ③ The UPS unit and the battery pack also can be placed horizontally without support feet, remember that put the battery pack under the UPS unit. The battery pack is heavy, be careful when you move it.

### 3.3.2 Rack installation

Please follow below steps to install the UPS unit into the rack mount enclosure.

- ① Attach mounting ears to the side mounting holes of UPS by using screws, and the ears should face forward, please refer to the diagrams.

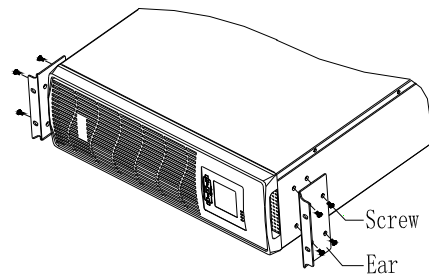

- ② Slide the UPS unit into the rack mount enclosure, attach the UPS to the rack with screws.

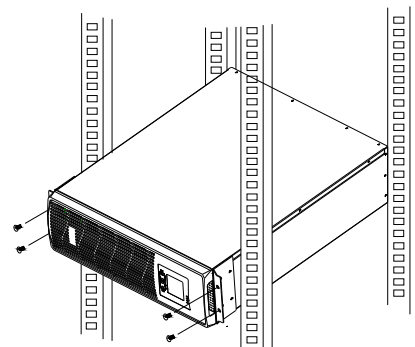

### 3.3.3 Single System output connection

Before installing, prepare wires for input and output of the UPS or isolation transformer based on the wiring spec table above in attention items.

- ① Normally, output connection of 6~10KVA type is configured with terminal blocks. Users can connect the load cable into the UPS output terminal to energize the load as following pictures. Make sure the mains wire and breakers in the building are enough for the rated capacity of UPS to avoid the hazards of electric shock or fire.

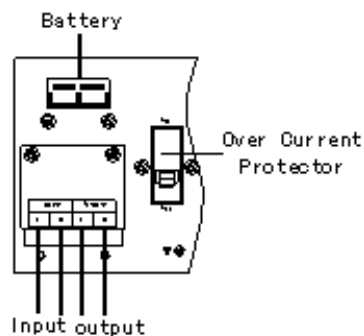

- ② UPS with isolation transformer installation and output connection

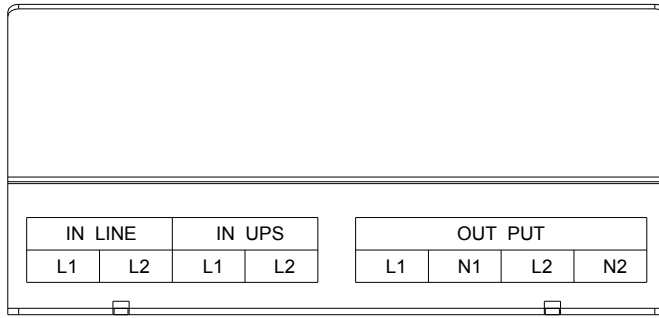

●IN LINE's L1 and L2 connect to mains(L1-L2), if the UPS system configure Manual Bypass Switch.

●IN UPS L1 connect to UPS's OUTPUT L, IN UPS L2 connect to UPS's OUTPUT N.

**Output configuration:**

●Configuration 1:

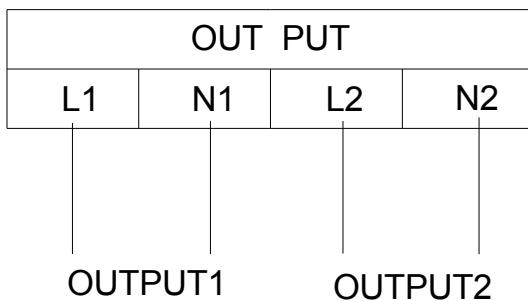

There are 2 sets of low-voltage output (104/110/115/120V) with L1-N1 and L2-N2. Each of them is able to provide 50% of UPS rating power. Connect one load to L1-N1 and the other load to L2-N2.

●Configuration 2 (N1 connect to L2):

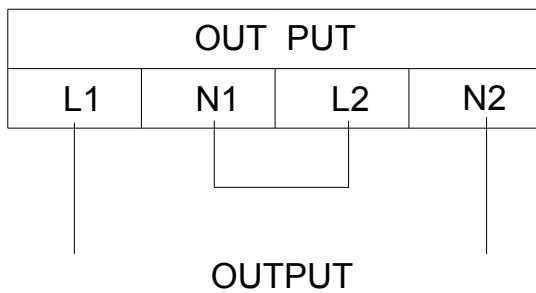

There is 208/220/230/240V high-voltage output with L1-N2 for 100% of UPS rating power.

●Configuration 3 (L1 connect to L2, N1 connect to N2):

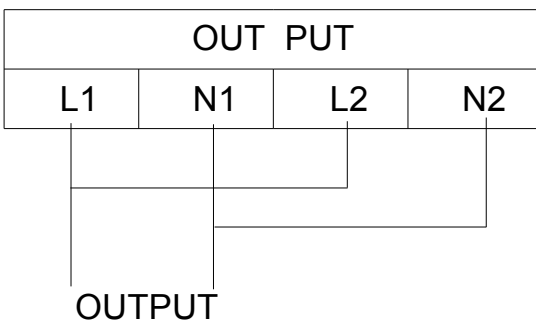



There is 104/110/115/120V low voltage output with L1-N2 for 100% of UPS rating power.

Note: For the type of 6-10KVA, do not use the wall receptacle as the input power source for the UPS, which rated current is less than the UPS's maximum input current. Otherwise the receptacle may be burned and destroyed.

### **3.4 Parallel system installation and output connection**

Only 6-10K UPS and containing parallel ports can do parallel operation, other types is not supported.

N+X parallel structure is the most reliable power supply structure at present, N stands for the minimum number of UPS for the load, X stands for the number of redundant UPS, X absolutely means how many UPS could be malfunctioning at the same time and the parallel UPS system is still steady. The larger X is, the system is more reliable. N+X is the best method for high reliability. Just install a little more simple accessories, at most 6 UPS could work together to form a flexible parallel system.

This structure of power supply system increases the power safety and reliability. For example, two single UPS make up a parallel system to load averagely, when one is malfunctioning, another one can take the whole load independently. It allows isolation repairs for malfunctioning UPS, and according to users own different requirements, every single UPS could install manual maintenance bypass switch.

#### **3.4.1 Parallel system installation**

The function of parallel operation is an optional function of UPS, users can purchase parallel function parts (including parallel card and parallel wire) and contact service personnel to install. At most 6 UPS work together by using parallel wires to form a flexible parallel system. Each UPS should be equipped individual battery pack.

##### **>Parallel system installation requirement**

- Install parallel wire, users need to purchase a specific parallel wire from our company, it's not recommended to use other type parallel wires. There are 2m length and 5m length to be chosen.
- Prepare wires for terminal block of the UPS based on the wiring spec table above in attention items.
- Each UPS input wiring please comply with the requirements of single UPS wiring.
- Every UPS is recommended to connect together to one common utility power terminal block.
- The output cables of each UPS are recommended to connect together on a common terminal block, then output to the load.
- Each UPS should be equipped individual battery pack.
- Wiring installation for parallel UPS system please refer to the wiring diagrams are given below, switches of 6KVA should withstand more than 40A/250VAC, and switches of 10KVA should withstand more than 63A/250VAC.
- Output wiring length requirements: when the distance between the load and each UPS is less than 20 meters, the length difference of cables to the load should be less than 20%; when the distance between the load and each UPS is more than 20 meters, the length difference of cables to the load should be less than 10%.

## > Installation procedure

① Install parallel wires. Two UPS to form an UPS parallel system, in order to ensure the reliability of the parallel system, there is only one way to wire two UPS, use two parallel wires to connect two UPS like the diagram showing below, connection looks like a circle. If three or more than three UPS are needed, the connection is similar, you can refer to the diagram as below. How many UPS unit, how many parallel wires you need.

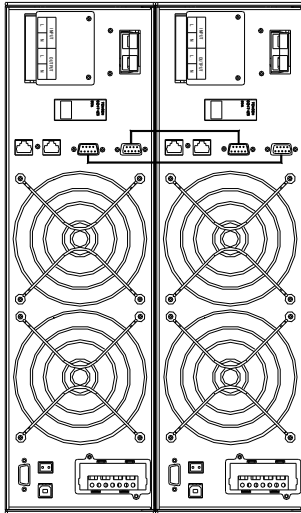

Parallel system of two UPS wiring

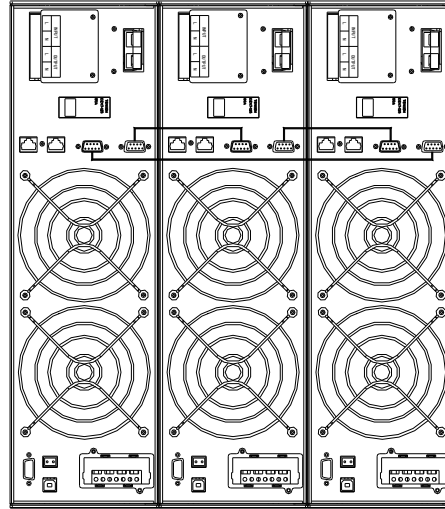

Parallel system of three UPS wiring

**⚠Attention:** For three UPS parallel system or more than three units system type, please remove the short pin CN3 on the parallel card as following pictures, Only keep the first unit and the last unit short pin(CN3) connected and remove the rest ones. Open the UPS cover, find the parallel card, it's installed on the rear panel. Take off the short pin CN3, then screw the cover back. It's advisable to contact to local dealer to operate, if you have to operate by yourself, please be sure that you have cut off all the electrical connection, be careful the electric shocks from the UPS inside.

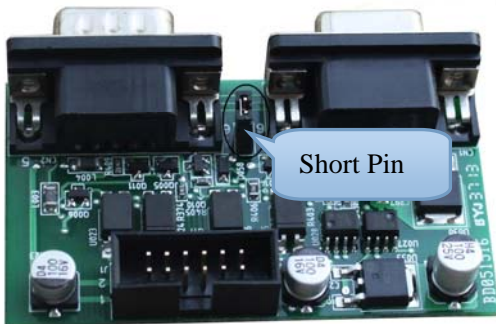

- ② Connect output cables of all UPS together to a common terminal block.
- ③ Connect input cables of all UPS together to one common utility power terminal block.

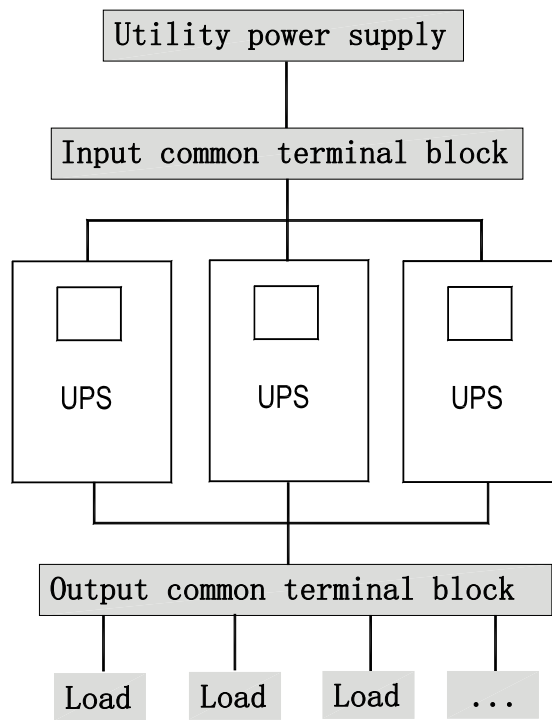

Parallel UPS system view

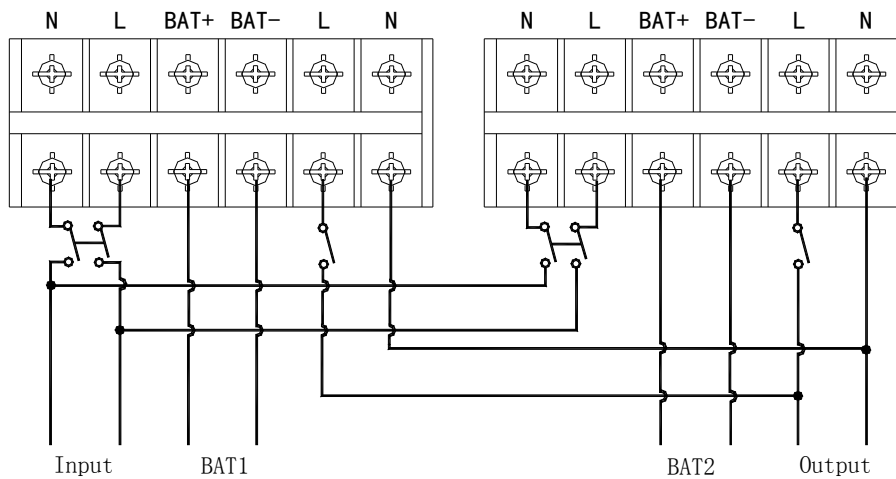

Wiring diagram for two UPS parallel system

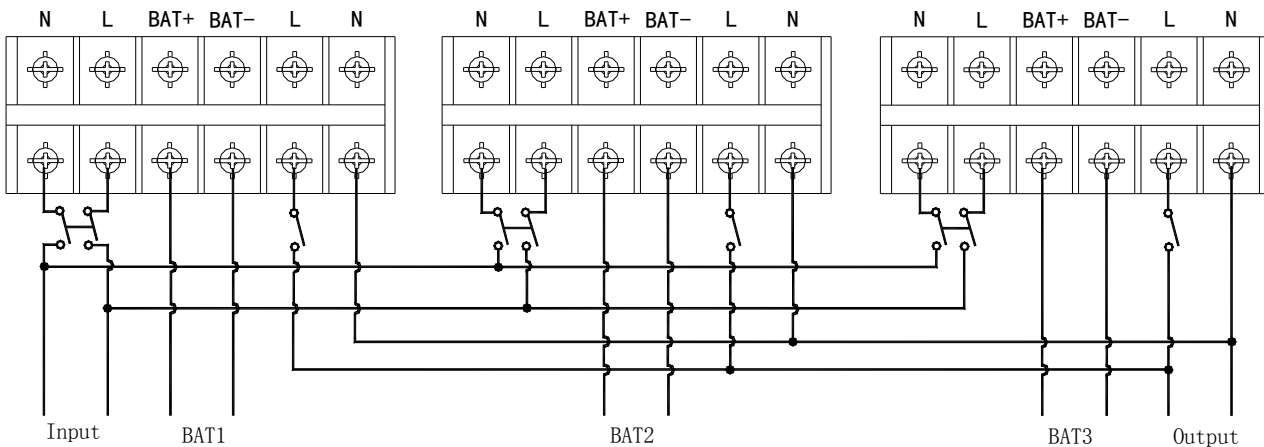

Wiring diagram for three UPS parallel system

④ If the UPS is the standard type, each UPS has batteries inside already. If the UPS is the long-run type, each UPS should be equipped a individual battery pack.

⑤ After installation, check all the wiring carefully, be sure to confirm correct, then can operate the system.

### 3.4.2 Parallel system operation and maintenance

General operation of parallel system, please refer to the operation instruction of single UPS. Before starting the system, need to set up different ID for each UPS, specific settings please refer to the instruction of ID setting which is given in single UPS panel function setting.

#### >Turn on the parallel system

- Start the system with mains power: After inputting the mains power, turn on any one UPS of system, others will start by themselves at same time. All UPS will enter into Line mode.

- Start the system without mains power: Make sure the battery pack is connected well and the breaker is in “ON” position. There are two ways to start the UPS parallel system without utility power supply:

A: Press the key  on each UPS, make each LCD of each UPS light up, then turn on any one UPS of system, others will start by themselves at same time. All UPS will enter into BAT mode.

B: Turn on UPS one by one.

#### >Turn off the parallel system

Hold on the OFF KEY of any one UPS of system for more than 4 seconds, it would turn off the whole parallel system. Hold on the OFF KEY of any one UPS of system for more than 1 second(less than 4 seconds), it would turn off single UPS you choose, of course if you need to turn on it again or turn on any other single UPS of the system, just press ON KEY of that UPS to start it.

#### >Parallel system maintenance

- Parallel system maintenance please follow the maintenance of single UPS.

- If one UPS of parallel system is malfunctioning, first of all, turn off the malfunctioning UPS, then cut off the input power to the faulty UPS and disconnect the output of faulty UPS to the parallel system, make sure that there is no electrical connection with malfunctioning UPS, after all of those, it's safe to do operation.

### 3.5 External battery connection (long back up model)

- For different UPS type, users are instructed to configure different battery voltage as below sheet. More or less units are forbidden, or else something abnormal or faulty will appear.

Type	Battery Quantity (unit)	Battery Voltage (volt)
6KVA	16	192
10KVA	16	192

- One end of battery cable is for UPS terminals while the other end with triple cables is for battery terminals. Correct installation procedure is highly vital or else probable electric shock will arise. Users are strictly required to follow the below procedure.

- Connect battery in correct way and make sure the total battery voltage is available for UPS.

- Correctly connect the long battery cable to battery terminals first, red wire is to positive plate

while black is to negative. If users connect the UPS first, electric shock or other danger could not be avoided.

- Before connecting load after UPS, users should supply main power to UPS and energize it.
- Connect long battery cable to UPS terminals with correct poles link (red is for “+”, black is for “-”), UPS will start the charging work automatically.

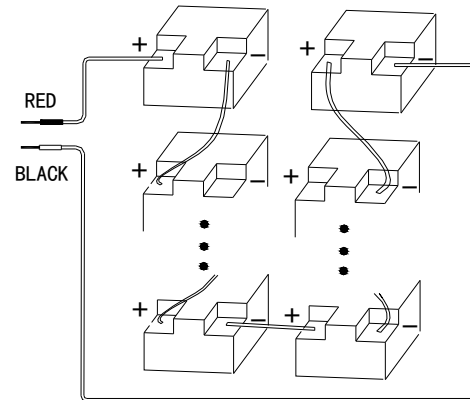
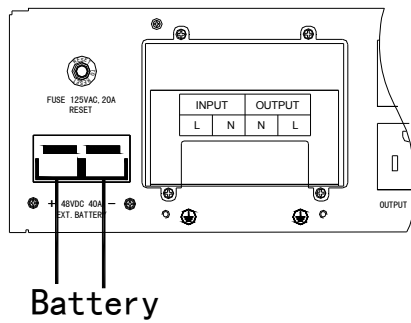

### 3.6 Network functions

#### 3.6.1 Communication port

Users could monitor the UPS system through the communication port such as standard RS232 port and standard USB port with computer. Connecting this UPS with computer by communication cable could achieve UPS management easily.

☆RS232 port:

Foot	1	2	3	4	5	6	7	8	9
Explanation	empty	send	receive	empty	ground	empty	empty	empty	empty

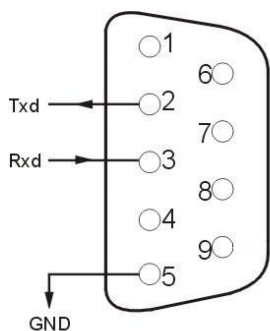

☆USB port:

Foot	1	2	3	4
Explanation	+5V	date+	date-	GND

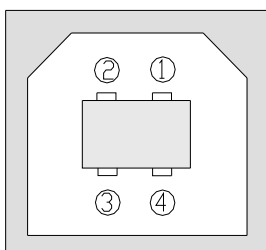

Note:

RS232 interface is set as below:

- Bit rate: 2400bps
- Byte: 8bit
- Completion code: 1bit
- Bit pattern: None

### 3.6.2 EPO port (optional)

EPO is the short for Emergency Power Off. EPO port is on the rear panel of the UPS. It's green. Users can cut off the output of UPS immediately by operating EPO port in case of emergency.

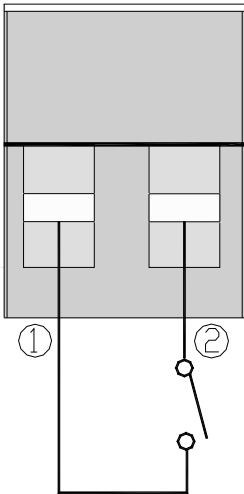

Normally, pin1 and pin2 are connected so that the machine can be working normally. When some emergencies happen, and when users do have to cut off the output, just need to disconnect the connection between pin1 and pin2, or there is a another useful simple way is pulling it out.

### 3.6.3 Intelligent card (optional)

There is an intelligent slot on the rear panel of the UPS. It's for SNMP card and dry contacts. Users can insert any type intelligent card from those three into it to monitor and manager the UPS. And users don't have to turn off the UPS when you install the intelligent card. Follow below process:

- Fist of all, remove the intelligent slot cover;
- Then insert the intelligent card (SNMP card or dry contacts);
- Finally, screw the intelligent card back.

#### > SNMP card (optional)

SNMP card on UPS is compatible with the most software, hardware and network operating system, it is a network management of UPS, with this function, UPS can login on internet , which can supply information of UPS status and input power, and even possible to control UPS via net management system.

#### > Dry contacts card (optional)

Insert the dry contact card into the intelligent slot, it's another type function of intelligent monitoring.

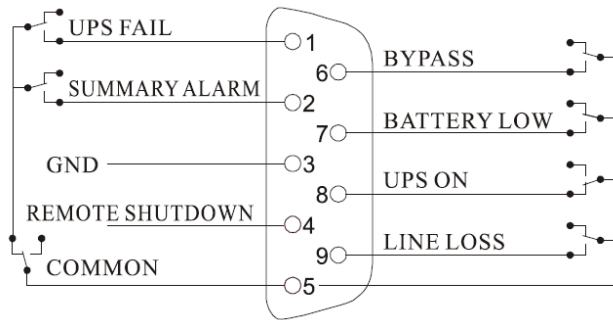

Foot	Definition
PIN1	ON: UPS is malfunctioning
PIN2	ON: Alarm (system failure)
PIN3	Ground
PIN4	Remote shutdown
PIN5	Common
PIN6	ON: Bypass mode
PIN7	ON: Battery low
PIN8	ON: Inverter mode; OFF: Bypass mode
PIN9	ON: No AC power in

## 4 Panel Function and Operation

The operation is simple, operators only need to read the manual and follow the operation instructions listed in this manual without any special training.

### 4.1 Keys function

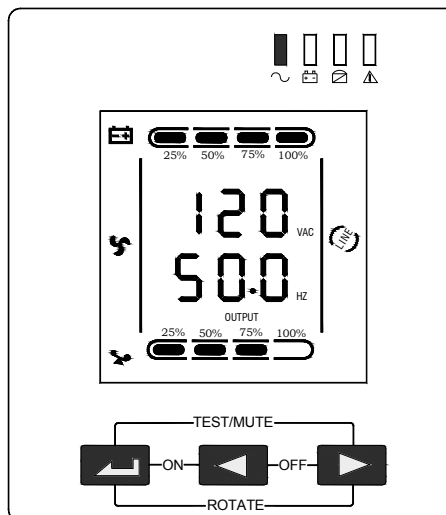

※ **ON/OFF key** ( ← + → )

Press and hold this key for more than half a second to turn on the UPS.

※ **OFF key** ( ← + → )

Press and hold this key for more than half a second to turn off the UPS.

※ **TEST/MUTE key** ( ← + → )

Press and hold the key in Line mode or ECO mode or CUCF mode: UPS runs the self-test function.

Press and hold the key for more than 1 second in battery mode: UPS runs the mute function.

※ **ROTATE key** ( ← + → )

Press and hold ← and → for more than 5 second: Change the direction to display items.

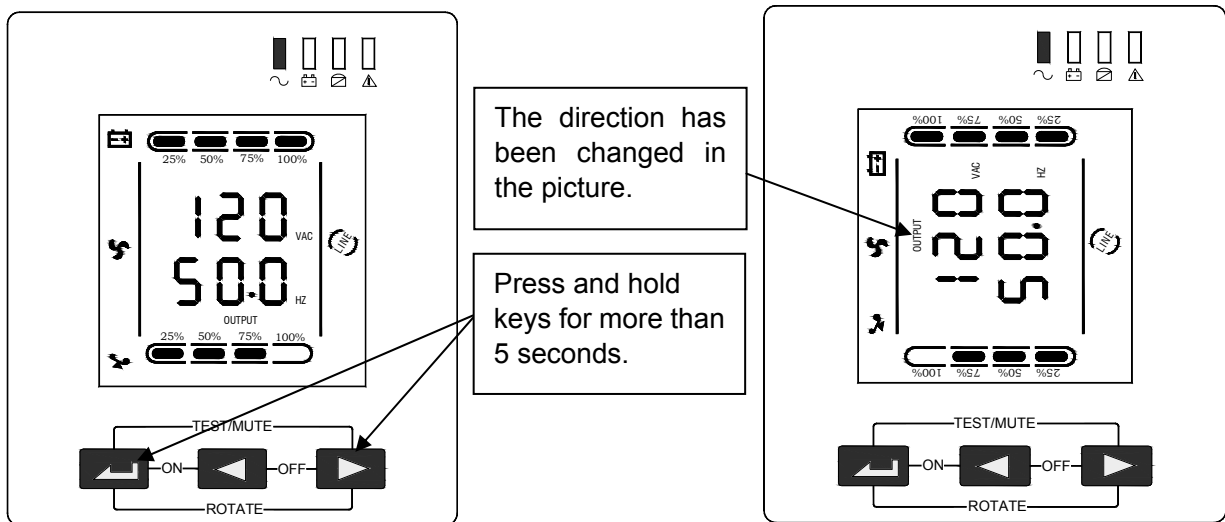

After finishing that, the machine can be placed flat, as shown in the picture below.

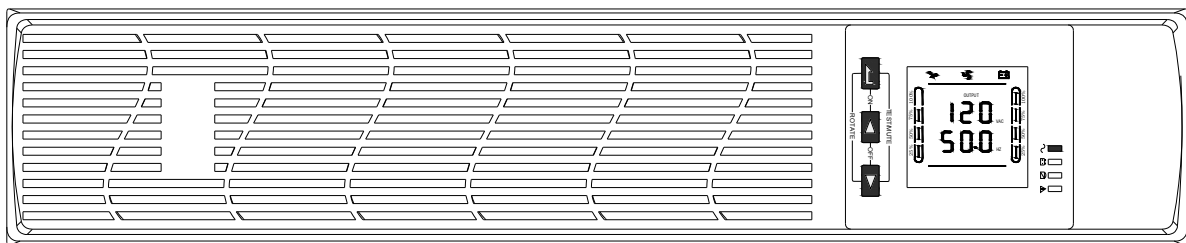

※ **INQUIRING key** ( ◀ , ▶ )

Non-function setting mode:

- 1) Press and hold ◀ or ▶ for more than half a second (less than 2 seconds): display the items orderly.
- 2) Press and hold ▶ for more than 2 seconds: Circularly and orderly display the items every 2 seconds, when press and hold the key for some time again, it will turn to output status.

Function setting mode:

Press and hold the key for more than half a second (less than 2 seconds): Select the set option.

※ **FUNCTION SETTING key** ↵

Non-function setting mode:

Press and hold the key for more than 2 seconds: Function setting interface.

Function setting mode:

Press and hold the key for more than half a second (less than 2 seconds): Enter the function setting option

Press and hold the key for more than 2 seconds, exit from this function setting interface.



## 4.2 LED Function

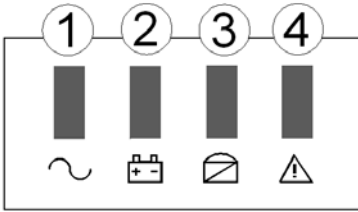

Number	LED	Explanation
①	Inverter LED	Inverter green LED is on: UPS is normally powered by Line mode or ECO mode or BAT mode.
②	Battery LED	Battery yellow LED is on: Battery mode.
③	Bypass LED	Bypass yellow LED is on: Bypass mode or ECO mode, etc.
④	Warning LED	Warning red LED is on: UPS fault. For example: Overload beyond the allowed time, inverter fault, BUS fault, over temperature fault, etc

PS: LED display detail in different mode is listed at the back.

## 4.3 LCD display function

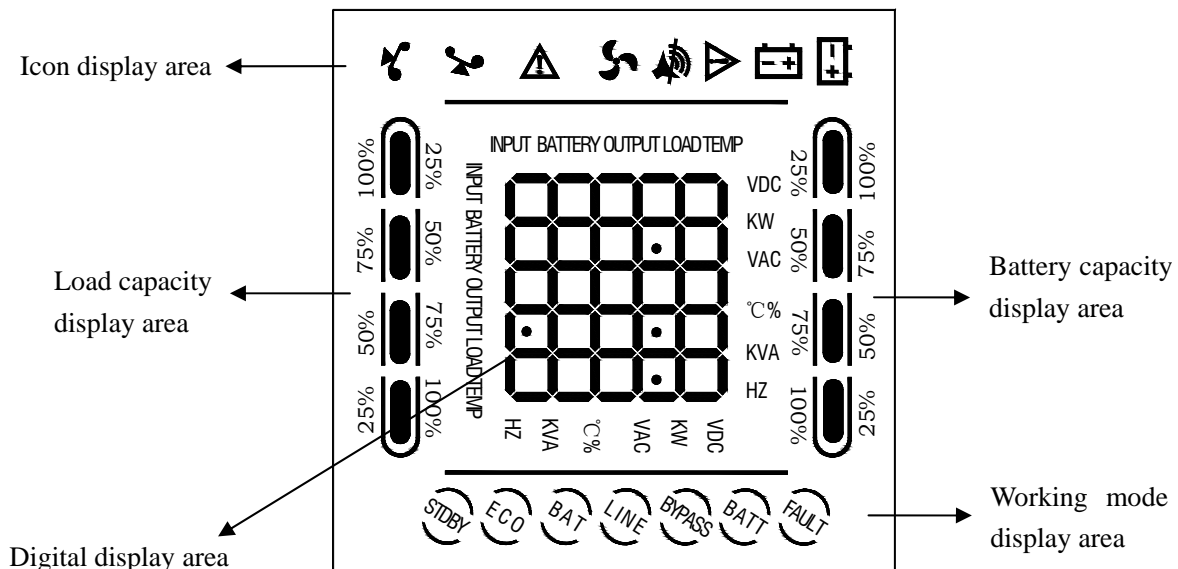

### ※ Icon display area:

- The top diagram is for load, battery, fan, fault and buzzer icon. When UPS is over loaded, the load light will blink as same as the battery light blinks when the capacity of battery gets low or battery is disconnected. The left icon and right icon are for load and battery capacity indication, each grid of which represents 25%.
- The fan icon is for fan working indication; when fan normally runs, the icon will display rotation; if the fan is not connected or faulty, the icon blinks;
- Press the mute button under the battery mode, buzzer icon will blink; it will disappear in other cases.
- Fault icon will be on when UPS is in fault mode, otherwise it will not.

### ※ Digital display area:

- Under none setting mode, it will display UPS output information when UPS normally runs in

AC mode; other information like input, battery, load and temperature will be showed after pressing the inquiring key; Fault code will be told in fault mode.

B. Under setting mode, users could adjust different output voltage, activate ECO mode, activate CUCF mode, select an ID number and so on by operating function setting key and inquiring keys.

※ **Mode display area:**

After over 20 seconds, this area will display the working mode of the machine. Such as STDBY(standby Mode), BYPASS(Bypass Mode), LINE(AC Mode), BAT(Battery Mode), BATT(Battery Self Test Mode ), ECO(Economic mode), SHUTDN(Shutdown mode), CUCF(Constant Voltage and Constant Frequency Mode).

## **4.4 On/Off operation**

### **4.4.1 Turn on the UPS**

> Turn on the UPS with mains power

① Once mains power is plugged in, the UPS will charge the battery, at the moment, LCD shows that the output voltage is 0, which means UPS has no output as default condition. If it is expected to have output of bypass, you can set the BPS “ON” by LCD setting menu.

② Press and hold the ON key for more than half a second to start the UPS, then it will start the inverter.

③ Once started, the UPS will perform a self-test function, and LED will light and go off circularly and orderly. When self-test finishes, it will come to online mode, the corresponding LED lights, UPS is working in line mode.

> Turn on the UPS by battery without mains power

① When main power is disconnected, press and hold the ON key for more than half a second to start UPS.

② The operation of UPS in the process of start is almost the same as that when mains power is on. After the self-test finishes, the corresponding LED lights and UPS are working in battery mode.

### **4.4.2 Turn off the UPS**

> Turn off the UPS in Line mode

① Press and hold the OFF key for more than half a second to turn off the UPS and inverter.

② After UPS shutting down, LED goes out and there is no output. If output is needed, you can set BPS “ON” on LCD setting menu.

> Turn off the UPS in battery mode without mains power

① Press and hold the OFF key for more than half a second to turn off the UPS.

② When turning off the UPS, it will do self-test first. LED lights go out circularly and orderly until there is no display on the panel.







## 4.5 Single UPS self-test/mute operation

- ① When UPS is in LINE Mode, press and hold the self-test/mute key for more than 1 second, LED light will go off circularly and orderly. UPS comes to self-test mode and tests its status. It will exit automatically after finishing test.
- ② When UPS is in BAT Mode, press and hold the self-test/mute key for more than 1 second, the buzzer stops beeping. If you press and hold the self-test/mute key for one more second, it will restart to beep again.

## 4.6 Single UPS panel function setting

UPS has setting function. It can run the setting in any mode. After setting, it will become effective at once when meets some standards. The set information can be saved only when the battery connected and normally turning off the UPS.

### 4.6.1 ECO mode setting

- ① Enter the setting interface. Press and hold the function setting key  for more than 2 seconds, then come to setting interface, the letters “ECO” will flash;
- ② Enter the ECO setting interface. Press and hold the function setting key  for more than half a second (less than 2 seconds), then come to setting interface of ECO, at this time, the letters “ECO” will not flash any more. The “ON” (or OFF) will flash. Press and hold the inquiring key (  ,  ) for more than half a second (less than 2 seconds) to determine whether the ECO function is used or not. If used, the corresponding word is “ON”, if not, the word is “OFF”. It can be determined by yourself.
- ③ Confirm the ECO selecting interface. After selecting ON or OFF, press and hold the function setting key  for more than half a second (less than 2 seconds). Now, the ECO setting function is completed and the “ON” or “OFF” will light without flash.
- ④ Exit from the setting interface. Press and hold function setting key  for more than 2 seconds, exit from the setting interface and return to main interface.

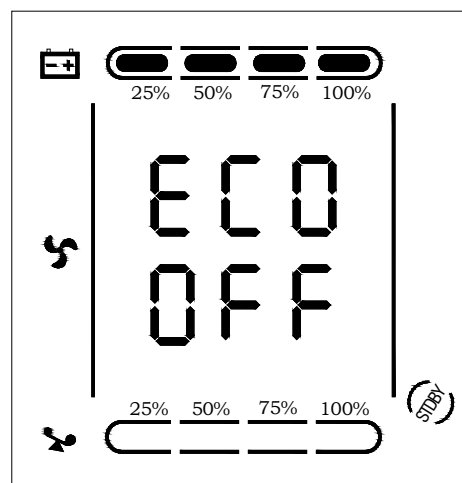
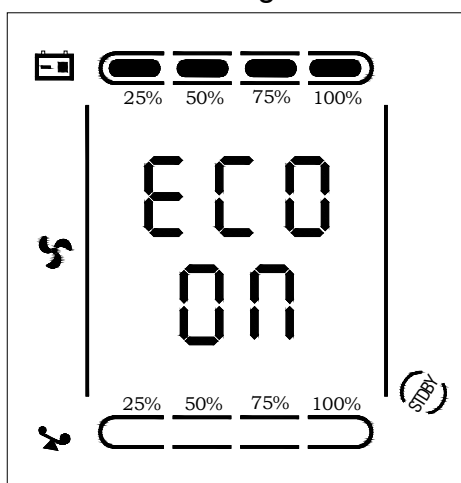

### 4.6.2 Output voltage setting

- ① Enter the setting interface. Press and hold the function setting key  for more than 2

- seconds, then come to setting interface, press and hold the inquiring key ( ◀ , ▶ ) for more than half a second (less than 2 seconds), select the function setting, choose output voltage setting interface, at the moment, the letters “OPU” will flash.
- ② Enter the output voltage setting interface. Press and hold the function setting key ⏏ for more than half a second (less than 2 seconds), then come to setting interface of output voltage OPU, at this time, the letters “OPU” will not flash any more. The numerical value next to the OPU will flash. Press and hold the inquiring key ( ◀ , ▶ ) for more than half a second (less than 2 seconds), select the numerical value in accordance with “OPU” function. The provided voltages are 208V, 220V, 230V, 240V or 100V, 110V, 115V, 120V, 127V, you can choose anyone by yourself (The default value is 220V or 120V).
  - ③ Confirm the output voltage setting interface. After selecting numerical value, press and hold the function setting ⏏ for more than half a second (less than 2 seconds). Now, the OPU setting function is completed and the numerical value will light without flash.
  - ④ Exit from the setting interface. Press and hold function setting key ⏏ for more than half a second (less than 2 seconds), exit from the setting interface and return to main interface.

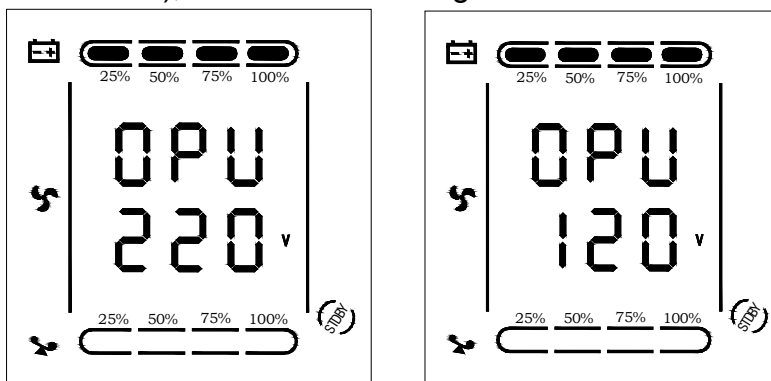

#### 4.6.3 Low voltage of battery setting







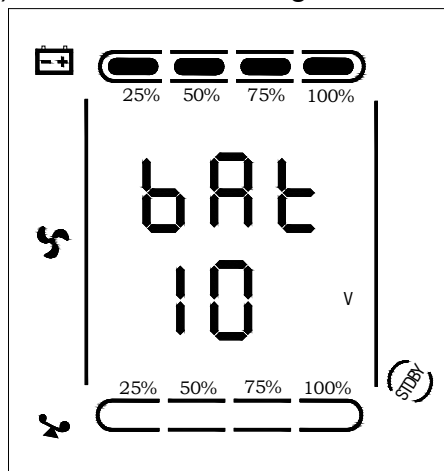

- ① Enter the setting interface. Press and hold the function setting key ⏏ for more than 2 seconds, then come to setting interface, Press and hold the inquiring key ( ◀ , ▶ ) for more than half a second (less than 2 seconds), select the function setting, choose battery voltage setting interface, at the moment, the letters “bat” will flash.
- ② Enter the battery voltage selecting interface. Press and hold the function setting key ⏏ for more than half a second (less than 2 seconds), then come to setting interface of battery voltage, this time, the numerical value will flash. Press and hold the inquiring key ( ◀ , ▶ ) for more than half a second (less than 2 seconds), select the numerical value in accordance with “battery” function. The provided voltages are 10V, 10.2V, 10.5V, numbers stand for the voltage of each battery, you can choose anyone by yourself (The default is 10V), anyone has been chosen, under BAT mode, UPS will shutdown when its battery voltage achieve the voltage you chose.
- ③ Confirm the battery voltage selecting interface. After selecting numerical value, press and hold the function setting ⏏ , for more than half a second (less than 2 seconds). Now, the

battery setting function is completed and the numerical value will light without flash.

- ④ Exit from the setting interface. Press and hold function setting key  for more than half a second (less than 2 seconds), exit from the setting interface and return to main interface.







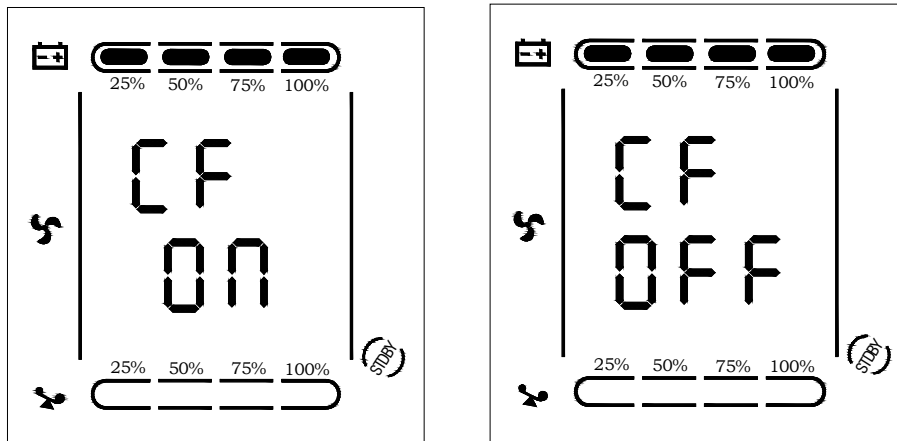



#### 4.6.4 Frequency converter mode setting

- ① CUCF mode only can be set in STDBY mode. In STDBY mode, enter the setting interface. Press and hold the function setting key  for more than 2 seconds, then come to setting interface, Press and hold the inquiring key (  ,  ) for more than half a second (less than 2 seconds), select the function setting, choose battery voltage setting interface, at the moment, the letters “CF” will flash.
- ② Enter the CF setting interface. Press and hold the function setting key  for more than half a second (less than 2 seconds), then come to setting interface of CF, at this time, the letters “CF” will not flash any more. The “ON” (or OFF) will flash. Press and hold the inquiring key (  ,  ) for more than half a second (less than 2 seconds) to determine whether the CF function is used or not. If used, the corresponding word is “ON”, if not, the word is “OFF”. It can be determined by yourself.
- ③ Confirm the CF selecting interface. After selecting ON or OFF, press and hold the function setting key  for more than half a second (less than 2 seconds). Now, the CF setting function is completed and the “ON” or “OFF” will light without flash.
- ④ Exit from the setting interface. Press and hold function setting key  for more than 2 seconds, exit from the setting interface and return to main interface.
- ⑤ After setting CF at “ON”, UPS would be back in STDBY Mode. The default value of CF is OFF.



#### 4.6.5 Output frequency setting in CUCF mode

- ① Output frequency only can be set when CUCF mode is ON.
- ② In STDBY mode, enter the setting interface. Press and hold the function setting key  for more than 2 seconds, then come to setting interface, Press and hold the inquiring key (  ,  ) for more than half a second (less than 2 seconds), select the function setting, choose battery voltage setting interface, at the moment, the letters “OPF” will flash.
- ③ Enter the OPF setting interface. Press and hold the function setting key  for more than half a second (less than 2 seconds), then come to setting interface of OPF, at this time, the letters “OPF” will not flash any more. The “OFF” (or 50HZ, 60HZ) will flash. Press and hold the inquiring key (  ,  ) for more than half a second (less than 2 seconds) to determine whether the CF function is used or not. If used, select 50HZ or 60HZ according to you. It is determined by yourself, the default value is 50HZ.
- ④ Confirm the OPF selecting interface. After selecting 50HZ or 60HZ, press and hold the function setting key  for more than half a second (less than 2 seconds). Now, the OPF setting function is completed and the “50HZ” or “60HZ” will light without flash.
- ⑤ Exit from the setting interface. Press and hold function setting key  for more than 2 seconds, exit from the setting interface and return to main interface.

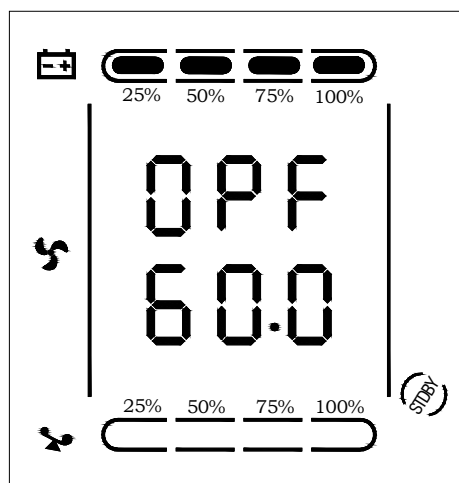

#### 4.6.6 ID setting

- ① Enter the setting interface. Press and hold the function setting key  for more than 2

seconds, then come to setting interface, press and hold the inquiring key ( ◀ , ▶ ) for more than half a second (less than 2 seconds), select the function setting, choose output voltage setting interface, at the moment, the letters “Id” will flash.

- ② Enter the output voltage setting interface. Press and hold the function setting key ◀ for more than half a second (less than 2 seconds), then come to setting interface of ID, at this time, the letters “Id” will not flash any more. The numerical value next to the “Id” will flash. Press and hold the inquiring key ( ◀ , ▶ ) for more than half a second (less than 2 seconds), select the numerical value. The provided ID numbers are 1, 2, 3, 4, 5, 6, 7, 8, you can choose anyone by yourself (The default value is 1).
  - ③ Confirm the output voltage setting interface. After selecting numerical value, press and hold the function setting ◀ for more than half a second (less than 2 seconds). Now, the ID setting function is completed and the numerical value will light without flash.
  - ④ Exit from the setting interface. Press and hold function setting key ◀ for more than half a second (less than 2 seconds), exit from the setting interface and return to main interface.
- Note: ID only can be set before doing parallel operation.

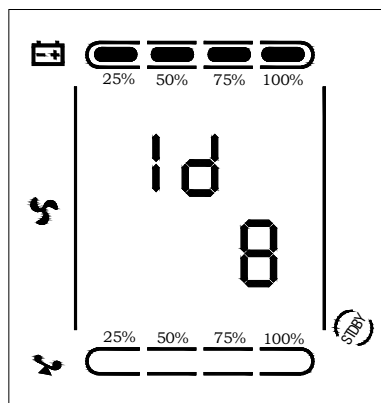

#### 4.7 Parameters inquiring operation

Press and hold the inquiring key ◀ or ▶ for more than half a second (less than 2 seconds) to inquire about items. The inquired items include input, battery, output, load and temperature. The displayed items on LCD screen are showed as following:

**Output:** Display the output voltage and output frequency of the UPS. As the following picture shows, the output voltage is 120V(220V), the output frequency is 50Hz.

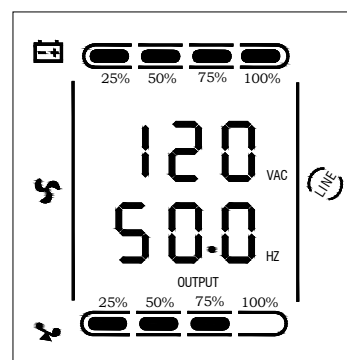
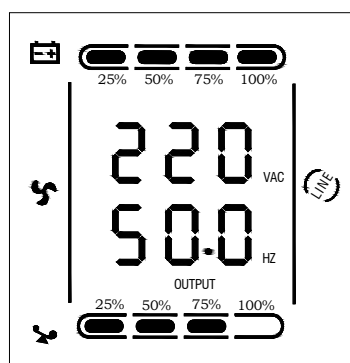

**Load:** Display the numerical value of the active power (WATT) and apparent power (VA) of the load. For example, as the following graphics shows: the WATT of the load is 800W(900W), VA is 1000VA (when disconnect load, it is a normal phenomenon to show a small numerical value of WATT and VA).

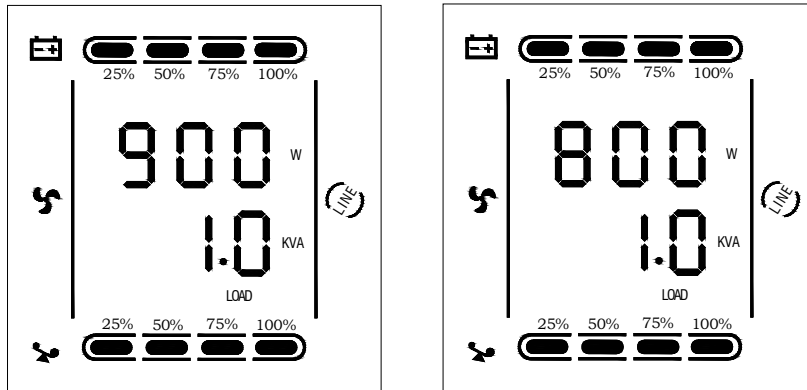

**Temperature:** Display the maximum temperature of the components in the UPS. As the following picture shows: the maximum temperature is 40°C.

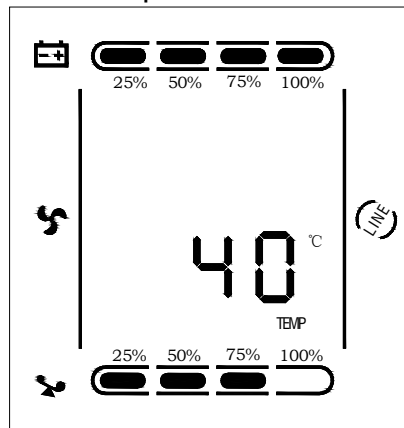

**Input:** Display the voltage and frequency of the input. As the following picture shows: the input voltage is 120V(220V), input frequency is 50Hz.

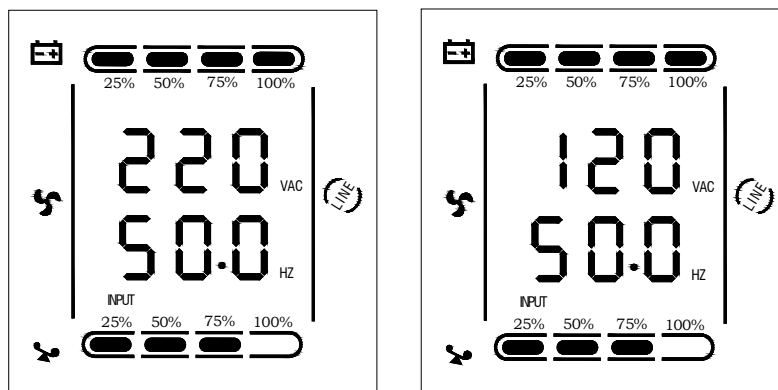

**Battery:** Display the voltage and capacity of the battery (determined by type). As the following picture shows: the battery voltage is 24V(36V), the capacity of battery is 100%(the capacity of battery is approximately reckoned according to the battery voltage).



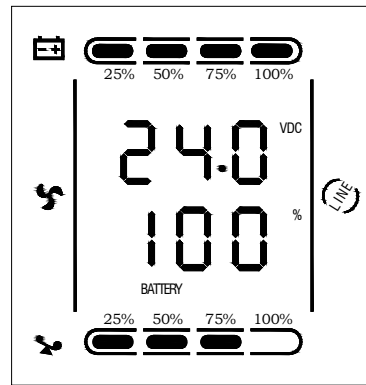
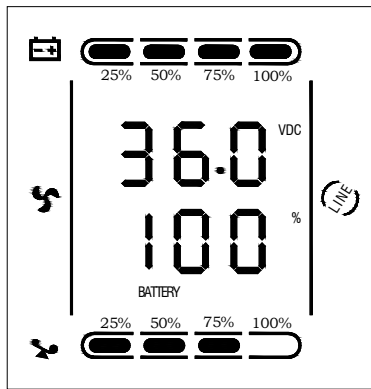

Press and hold the inquiring key ◀ for more than 2 seconds, LCD begins to display the items circularly and orderly which transfer to another every 2 seconds. Press and hold the key for some time again within 30s, it will return to output status.

## 5 Operation Mode

### 5.1 Bypass mode

LED indications on front panel in bypass mode are as following:



Bypass yellow LED is on, the buzzer beeps once every 2 minutes. The warning red LED is on when beeping, what LCD displays depending on the exact load and battery capacity.

Turn to bypass mode under the following two conditions:

- ① Turn off the UPS line mode while start the bypass output.
- ② Overload in line mode.

**Note:** When UPS is working in bypass mode, it has no back up function.

### 5.2 Line mode

LED indications on front panel in line mode or CUCF mode are as following: The inverter green LED is on.



When input AC mains correspond to the working conditions, UPS will work in line mode.

### 5.3 Battery mode

LED indications on front panel in battery mode are as following: both the inverter green LED and battery yellow LED is on, the buzzer beeps once every 4 seconds. The warning red LED will be on while beeping.



When the mains power is low or unstable, UPS will turn to battery mode at once.

## 5.4 ECO mode

LED indications on front panel in ECO mode are as following: both the inverter green LED and bypass yellow LED are on.



When the input mains meets the input range of the ECO mode and the ECO function is on, the UPS will work in ECO mode. If input AC mains exceed the range of ECO several times within one minute but stays in inverter input range, UPS will work in AC inverting mode automatically.

## 5.5 Fault mode

LED indications on front panel in Fault mode are as following: warning red LED is on and LCD display fault code and related icon.

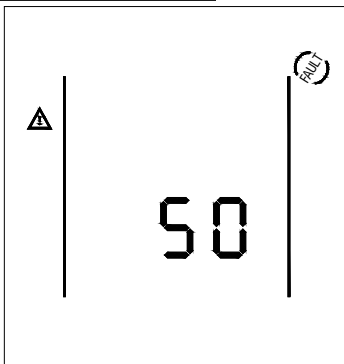

Fault mode (LCD interface on which the fault code display)

When the UPS is failed, the warning LED is on and the buzzer beeps. UPS will turn to fault mode. UPS cuts off the output and LCD display fault codes. At the moment, you can press the mute key to make the buzzer stop beeping temporarily to wait for maintenance. You can also press the OFF key to shut down the UPS when confirmed that there is no serious fault.

## 6 Fault Messages and Alarm

**Table 1: Fault code messages**

Fault code	Fault type	Bypass output	Note
0、 1、 2、 3、 4	Bus high	yes	
5、 6、 7、 8、 9	Bus low	yes	
10、 11、 12、 13、 14	Bus unbalance	yes	
15、 16、 17、 18、 19	Bus soft start fail	yes	
20、 21、 22、 23、 24	Inverter soft start fail	yes	
25、 26、 27、 28、 29	Inverter high	yes	
30、 31、 32、 33、 34	Inverter low	yes	
35、 36、 37、 38、 39	Bus discharge fail	yes	
40、 41、 42、 43、 44	Over heat	yes	
45、 46、 47、 48、 49	OP(inverter) short	no	

50、51、52、53、54	Overload	yes	
55、56、57、58、59	Line NTC break	yes	
60、61、62、63、64	Shutdown fault	yes	
65、66、67、68、69	Incompatible parallel function version	yes	
70、71、72、73、74	Communication fault	yes	unused
75、76、77、78、79	Communication fault	yes	
80、81、82、83、84	Relay fault	yes	
85、86、87、88、89	BUS short	yes	unused
90、91、92、93、94	CAN fault	yes	
95、96、97、98、99	ID conflict	yes	
100、101、102、103、104	Incompatible type	no	
105、106、107、108、109	Battery quantity setting fault	yes	
110、111、112、113、114	AC input SCR fault	yes	
115、116、117、118、119	EPO fault	yes	

**Table 2: Working status messages**

S/N	Working status	LED on Front panel				Alarm beep	Note
		Normal	Battery	Bypass	Fault		
1	Inverter mode (mains power)						
	Mains power voltage	●				N	
	Mains power high/low voltage protection, switch to battery mode	●	●		★	One beep / 4 sec	
2	Battery mode						
	Battery voltage - normal	●	●		★	One beep / 4 sec	
	Warning for abnormal voltage of battery	●	★		★	One beep / sec	
3	Bypass mode						
	Mains power – normal (under Bypass)			●	★	One beep / 2 mins	
	Mains power – high voltage warning (under Bypass)			●	★	One beep / 4 sec	
	Mains power – low voltage warning (under Bypass)			●	★	One beep / 4 sec	
4	Warning for battery disconnected						
	Bypass mode			●	★	One beep / 4 sec	
	Inverter mode	●			★	One beep / 4 sec	
	Power on / Switch on					6 beeps	

5	Output overload protection						
	Warning for mains power overload	•			★	2 beeps / sec	
	Protect operation for mains power mode overload			•	•	Long beep	
	Warning for battery overload	•	•		★	2 beeps / sec	
	Protect operation for battery mode overload	•	•		•	Long beep	
6	Warning for bypass mode overload			•	★	One beep / 2 sec	
7	Fans fault(fan icon)	▲	▲	▲	★	One beep / 2 sec	
8	Faults mode				•	Long beep	

• LED indicator lights long time

★ LED indicator flicker

▲ LED indicator status depends on other conditions

**Note:** End user need to provide below information when require to maintain the UPS.

- UPS Model No. & Serial No.
- Date of fault occurrence.
- Fault detail (LED status, noise, AC power situation, load capacity, for long back up type, battery capacity configuration is also necessary.)

## 7 Troubleshooting

When the system works in fault mode, the LCD displays as below:

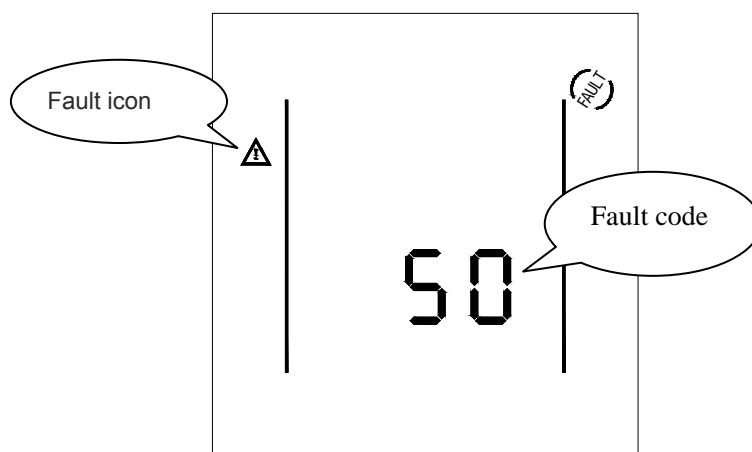

Problem	Possible Cause	Solution
Fault LED on, audible buzzer Persistently alarm, the fault code is 00-14	Bus bar voltage fault	Please test the bus bar voltage or contact the supplier.

Fault LED on, audible buzzer persistently alarm, the fault code is 15-24	Soft start fault	Please check the soft start up circuit, especially the soft start resistance or contact the supplier directly.
Fault LED on, audible buzzer persistently alarm, the fault code is 25-39	Inverter voltage fault	Please contact the supplier.
Fault LED on, audible buzzer persistently alarm, the fault code is 40-44	Over temperature inside	Please make sure the UPS didn't get overload, and the fan vent was not obstructed, as well as the indoor temperature is not high. Leave alone the UPS 10 minutes for cooling, and restart it. If failure remains, please contact the supplier.
Fault LED on, audible buzzer Persistently alarm, the fault code is 45-49	Output short-circuit	Turn of the UPS and disconnect all the load, make sure there no any fault or internal short circuit of the load. And then restart the UPS, if failure still, please contact the supplier.
Fault LED on, audible buzzer persistently alarm, the fault code is 50-54	Over load	Please check the load level and disconnect the noncritical devices, recount the total capacity of your load and reduce the load to the UPS. Please check whether the load device has fault or not?
Fault LED on, audible buzzer persistently alarm, the fault code is 55-59	Input NTC fault	Please contact the supplier.
Fault LED on, audible buzzer persistently alarm, the fault code is 60-64	Power fault	Please Check whether the input & output power normal or not, contact the supplier if it is abnormal.
Fault LED on, audible buzzer persistently alarm, the fault code is 65-69	Input fuse fault	Please check if the input fuse is burnt. Replace the old fuse and restart the UPS. If failure remains, please contact the supplier.
Fault LED on, audible buzzer Persistently alarm, fan icon in the LCD flickers	Fan fault	Please check whether the fans connect well, is the fan plugged and is the fan broken? If all above condition is ok, please contact the supplier.
UPS fail to start when operate "On" key	Pressing time too short	Please press the power key more than 2 seconds to start the UPS.
	The input connection is not ready or UPS internal battery disconnect	Please connect the input well, if the battery voltage is too low, please disconnect the input and start the UPS with no-load.
	UPS internal system	Please contact the supplier.

	fault	
Back up time become short	Battery undercharge	Please keep the UPS battery recharging more than 3 hours
	UPS overload	Please check the load level and disconnect the noncritical devices,
	Battery maturing, capacity descend	Please change new battery, contact your supplier to get the new battery and spare parts.
UPS doesn't have any power go through even main power on	UPS input breaker disconnects	Please reset the circuit breaker by manual.













⚠ **Note:** When the output is short-circuited, the action of the protection of the UPS will show up. Before turning off the UPS, please make sure to disconnect the entire load and cut off the AC mains power supply, otherwise will make the AC input short-circuit.

## Appendix 1: EMC Level

The series product is designed to meet the below standard.

EMS	
IEC61000-4-2(ESD)	Level 4
IEC61000-4-3(RS)	Level 3
IEC61000-4-4(EFT)	Level 4
IEC61000-4-5(Surge)	Level 4
EMI	
GB9254-1998/IEC 62040-2	Class B

## Appendix 2: Symbols

Symbol	Description	Symbol	Description
	Caution		Protect grounding
	Danger! High Voltage!		Alarm cancel
ON	Turn on		Overload
OFF	Turn off		Battery inspection
	Standby or Shutdown		Repeat
	AC		Display screen repeat key
	DC		Battery

### Appendix 3: Specifications

Rated Capacity		6KVA	10KVA
<b>Input</b>			
Rated input voltage		220V	
Rated input frequency		50Hz/60Hz auto-adaptive	
Input voltage range		(115~165)±5VAC (linear derating between 50% and 100% load); (165~295)±5VAC(full load)	
Input frequency range		40-70Hz, +/-0.5%	
Input current		40A max	60A max
PFC		≥0.99	
THDI		< 5%	
Bypass voltage range		(73%~115%)*Rated output voltage	
<b>Output</b>			
Output voltage		208VAC/220VAC/230VAC/240VAC Setting available via LCD	
Output PF		0.9	
Output power(Watt)		5400	9000
Inverter overload capability		105%~125%: 3 mins; 125%~150%: 30 secs; > 150%: 100ms;	
Voltage accuracy		±1%	
Load crest		3:1	
From AC mode to BAT mode		0ms(transfer time)	
From BAT mode to AC mode		0ms(transfer time)	
Efficiency	Line mode	≧ 92%	
	BAT mode	91%	
	ECO mode	98%	
<b>Output frequency</b>			
Line mode		Same as input frequency	
BAT mode		(50/60±0.2)Hz	
CUCF mode		(50/60±0.2)Hz	
Phase-locked rate		≤1Hz/s	
Total voltage harmonic distortion		Full linear load< 2%; Full nonlinear load< 5%	
<b>Battery</b>			
Battery type		Sealed lead acid maintenance free battery	
Quantity		16	
DC voltage		192V	
Output voltage		216.8±1V	
Inbuilt battery		16*7AH/12V	16*9AH/12V
Charge method		Shift between Float and Equalizing Charging automatically	
Back up time		Based on battery capacity	

Charge current	Standard model:1A
	Long time model: 1A /3A /5A /8A
<b>System Control and Communication</b>	
Function	Silence; cold start; AC restart; Auto restart.
Protection	Over-temp protection; Fan testing protection; Output short circuit protection
Communication port	RS232; SNMP card; USB; Dry contact
Software function	Graphics analyze; Switch on/off UPS system; Monitor UPS working status; History record and event log
Display	LCD/LED

\* Derate capacity to 70% in CUCF mode and to 90% when the output voltage is adjusted to 208VAC.

#### Appendix 4: Physical

Rated Capacity		6KVA	10KVA
Dimension (W*D*H)	UPS	440×580×132	
	Battery pack	440×580×132	
	isolation transformer unit	440×537.5×132	
Weight (Kg)	Long	20.7	22.4
	Standard	20.7	22.4
	Battery pack	52	52